

MTB[®]

THE CRUSHING EVOLUTION



UŠTEDITE > RECIKLIRAJTE > PONOVO KORISTITE

JEDAN SISTEM, VIŠE POLJA PRIMENE

RUŠENJE



**RADOVI NA
PUTEVIMA**



**GRADILIŠTA
U URBANIM
SREDINAMA**



RECIKLAŽA



ISKOPI



**ODRŽAVANJE ZELENIH
I POLJOPRIVREDNIH
POVRŠINA**



MB REZULTATI

ARMIRANI BETON



RUŠENJE



REČNI KAMEN





WWW.MBCRUSHER.COM



KOMUNALNI POSLOVI 





KAMENOLOMI 

RUDNICI 



TUNELI 



RAD UNUTAR OBJEKATA 



INDUSTRIJSKE ZONE 



BAZALT



KREČNJAK



GRANIT





DROBILIČNA KAŠIKA

MB nudi širok spektar efikasnih, visoko kvalitetnih i patentiranih drobiličnih čeljusti, dizajnirane tako da transformišu svaku građevinsku mašinu u pravu drobilicu.

U SVETU, NAJŠIRI SPEKTAR DROBILIČNIH DODATAKA ZA BAGER SA VIŠE **OD 90% UDELA NA TRŽIŠTU**

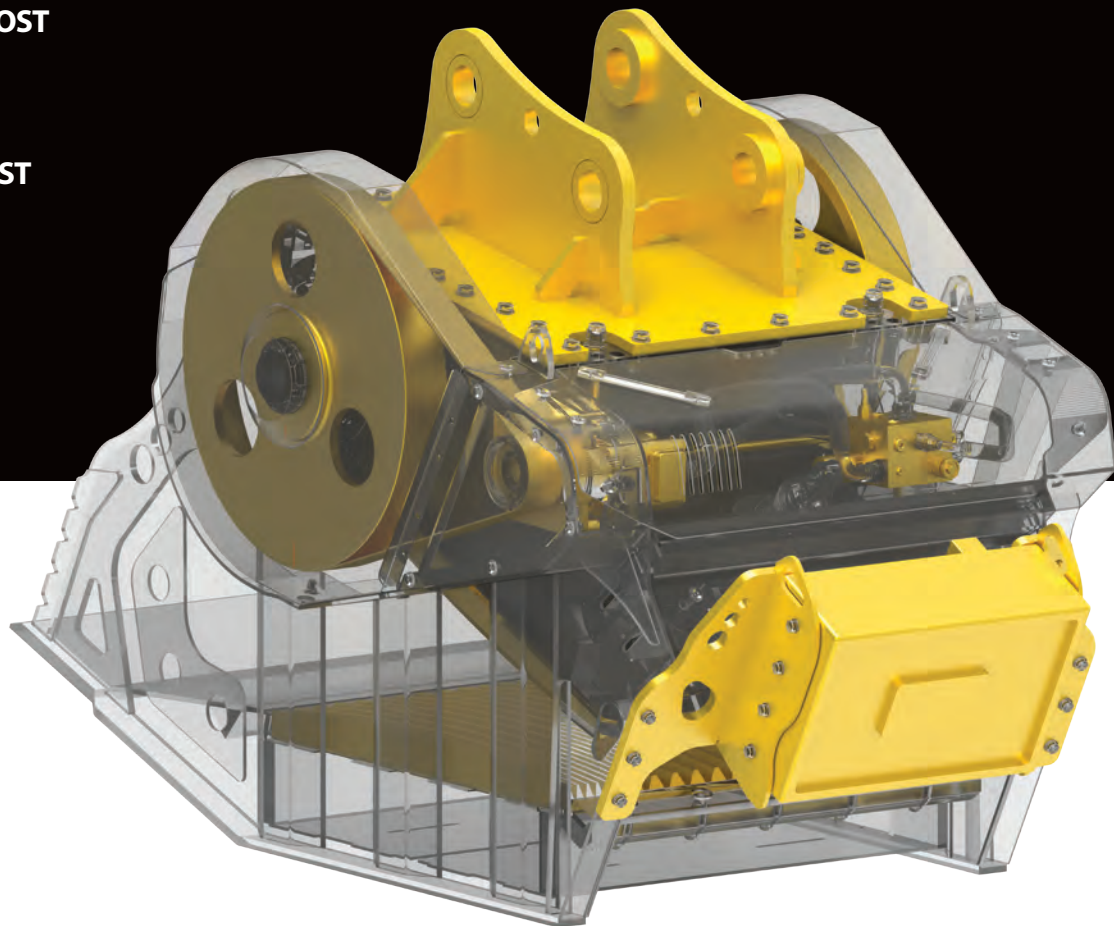



- +** BRZO I LAKO ODRŽAVANJE
- +** EFIKASNA HIDRAULIKA
- +** PRODUKTIVNOST
- +** STABILNOST
- +** OPREMLJENOST
- +** HARDOX®

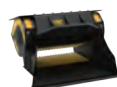

MODELI

* zadnji



MODEL	MB-L120 S2	MB-L140 S2	MB-L160 S2	MB-L200 S2
 PREPORUČENI BAGER GUSENIČAR	-	-	-	-
 PREPORUČENI MINI UTOVARIVAČI	≥ 2,8 Ton	≥ 3 Ton	≥ 4,5 Ton	≥ 6 Ton
 PREPORUČENE KOMBINIRKE/UTOVARIVAČI I/TELEHENDLERI	≥ 5 ≤ 7 Ton	≥ 6 ≤ 8 Ton	≥ 7 ≤ 10 Ton	≥ 7 ≤ 10 Ton
 PREPORUČENI/MINI BAGERI	-	-	-	-
TEŽINA	0,95 Ton	0,98 Ton	1,45 Ton	1,50 Ton
KAPACITET UTOVARA	0,20 m ³	0,25 m ³	0,35 m ³	0,45 m ³
PRITISAK	200 bar	200 bar	200 bar	200 bar
PROTOK ULJA	95 l/min.	98 l/min.	110 l/min.	120 l/min.
DIMENZIJE OTVORA	L 730 H 250 mm	L 740 H 250 mm	L 1100 H 240 mm	L 1150 H 260 mm

WWW.MBCRUSHER.COM



SAZNAJTE
VIŠE

MB PERFORMANSE



**POTVRĐENA I GARANTOVANA
GRANULACIJA IZLAZNOG
MATERIJALA**



Dizajnirano da sa lakoćom utovari
i preradi materijal, istovremeno
**GARANTUJUĆI KVALITET I
POVEĆANU PRODUKTIVNOST**



**HIDRAULIČNI RASHLADNI
SISTEM MB** drobilčnih kašika je
ranga **AAA+** što čuva i produžava
radni vek bagera



**NAJŠIRI IZBOR RASPONA
DROBILIČNIH OTVORA,
zavisno od težine bagera**



BRZO I LAKO ODRŽAVANJE
bez potrebe zamene ulja



Opremljeno kontrolnom jedinicom
KOJA ELIMINIŠE VIBRACIJE na
bagerskoj ruci

REGULACIJA VELIČINE IZDROBLJENOG MATERIJALA mm	MB-L120	MB-L140	MB-L160	MB-L200	MB-C50	BF 60.1	BF 70.2	BF 80.3	BF 90.3	BF 120.4	BF 135.8	BF 150.10
	m ³ /h	m ³ /h	m ³ /h	m ³ /h	m ³ /h	m ³ /h	m ³ /h	m ³ /h	m ³ /h	m ³ /h	m ³ /h	m ³ /h
200											120	120
150											88	95
145											85,7	91,1
140											83,5	87,6
135											81,3	84,1
130						23	31	33	38,8	47,2	79,1	82,5
120						21	30	31	36,5	44,4	74,5	76,6
110						19,8	28	29	34,2	41,6	70,1	73,1
100						18,5	26	27	31,8	38,8	65,6	68,6
90						17,1	24	25	29,5	36	61,1	64,1
80						15,8	22	23	27,2	33	56,6	59,6
70	14	16	20	22	10	14,4	20	21	24,8	30,4	52,2	55,2
60	13	15	17,6	19,3	9,3	13	18	19	22,5	27,6	47,6	50,6
50	11	13	15,1	16,7	7,8	11,7	16	17	20	24,8	43,2	46,2
40	9	11	12,7	14	6,3	10,4	14	15	17,8	22	38,7	41,7
30	7	9	10,2	11,3	4,8	7,7	10	11	13,2	16,4		
20	6	8	9	10	4	7	9	10	12	15		
15												

PRODUKTIVNOST DROBILIČNE KAŠIKE: da biste dobili vrednosti u tonama/sat, pomnožite podatke navedene u tabeli za specifičnu težinu vašeg materijala.
Vrednosti su potpuno indikativne, procenjene sa materijalima srednje žilavosti.

PRIBOR

- SEPARATOR GVOŽĐA
- BROJAČ SATI RADA
- ELIMINATOR PRAŠINE
- PRODUŽENA GARANCIJA GOLD 2 GODINE
- PREPORUČENI KOMPLET REZ. DELOVA
- ADAPTER (PRIKLJUČNA PLOČA) ZA BAGER
- BRZA SPOJKA



MB-C50 S2

≥ 3,5 Ton



BF60.1 S4

≥ 8 Ton



BF70.2 S4

≥ 14 Ton



BF80.3 S4

≥ 18,5 Ton



BF90.3 S4

≥ 21 Ton



BF120.4 S4

≥ 30 Ton



BF 135.8

≥ 43 Ton



BF 150.10

≥ 70 Ton

-	-	-	-	-	-	-	-
-	-	-	-	-	-	-	-
* ≥ 4 Ton	-	-	-	-	-	-	-
0,75 Ton	1,60 Ton	2,30 Ton	3 Ton	3,50 Ton	4,80 Ton	7,50 Ton	10,50 Ton
0,15 m ³	0,55 m ³	0,66 m ³	0,70 m ³	0,90 m ³	1,30 m ³	1,60 m ³	2,30 m ³
200 bar	220 bar	220 bar	220 bar	220 bar	220 bar	250 bar	230 bar
90 l/min.	98 l/min.	140 l/min.	160 l/min.	180 l/min.	210 l/min.	320 l/min.	380 l/min.
L 540 H 250 mm	L 610 H 500 mm	L 740 H 510 mm	L 850 H 510 mm	L 910 H 540 mm	L 1205 H 540 mm	L 1300 H 600 mm	L 1450 H 700 mm

REŠETKASTA KAŠIKA (SITO)

MB Crusher nudi najrazličitije vrste sita-kašika koje su raspoložive na tržištu, dizajnirane da se mogu montirati na sve vrste građevinskih mašina. Opremljene su zamenljivim modularnim panelima za bilo koju željenu i potrebnu frakciju materijala.







- + VISOKA PRODUKTIVNOST
- + POUZDANE I VISOKIH PERFORMANSI
- + LAKO ZA TRANSPORT
- + JEDNOSTAVNO
- + MAKSIMALNA SVESTRANOST
- + OPREMLJENOST
- + HARDOX®

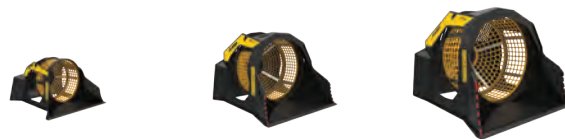

MODELI

* zadnji



MODEL	MB-LS140	MB-LS170	MB-LS220 S2
 PREPORUČENI BAGER	-	-	-
 PREPORUČENI MINI UTOVARIVAČ	≥ 2,6 Ton	-	-
  PREPORUČENE KOMBINIRKE/UTOVARIVAČ	-	≥ 6,5 < 11 Ton	≥ 12 < 25 Ton
  PREPORUČENI MINI BAGERI	-	-	-
TEŽINA	0,45 Ton	1,35 Ton	2,80 Ton
UTOVARNI KAPACITET	0,40 m ³	1,10 m ³	2,40 m ³
RADNI PRITISAK / POVRATNI PRITISAK	130 bar	150 bar	220 bar
PROTOK ULJA	40 l/min.	60 l/min.	120 l/min.

WWW.MBCRUSHER.COM



SAZNAJTE
VIŠE

MB PERFORMANSE



Korpe dizajnirane u obliku konusa sa veličinom i dubinom **DA SE OPTIMIZIRA PRODUKTIVNOST**



Na tržištu, **NAŠE KAŠIKE- SITA IMAJU NAJVEĆU POVRŠINU PROSEJAVANJA** u odnosu na težinu mašine



DIZAJNIRANO ZA LAKO UTOVARIVANJE I PROSEJAVANJE MATERIJALA



Opremljeno **KONTROLNIM SISTEMOM ZA PUNJENJE**



Opremljeno **NOSAČIMA I ZAŠTITOM KORPE**



BRZA LAGANA IZMENA promenljivog modularnog panela, raspoloživog u raznim dimenzijama otvora

RAZLIČITE APLIKACIJE UPOTREBE

- RECIKLAŽA
- KOMUNALNA DELATNOST
- URBANA SREDINA
- KAMENOLOMI
- RUDNICI
- ŽIVOTNA SREDINA
- UNAPREDJENJA U POLJOPRIVREDI

PRIBOR

- BRZA IZMENA
- SEPARATOR GVOŽĐA
- BROJAČ SATI RADA
- ODSTRANJIVAČ PRAŠINE
- PRODUŽENA GARANCIJA GOLD 2 GODINE
- PREPORUČENI REZ. DELOVI
- KIT ZA ZAŠTITU KAŠIKE
- ADAPTER (PRIKLJUČNA PLOČA)



MB-S10 S4

≥ 3,5 Ton



MB-S14 S4

≥ 9 < 20 Ton



MB-S18 S4

≥ 20 < 35 Ton



MB-S23

≥ 35 Ton

-	-	-	-
-	-	-	-
* ≥ 4 < 9 Ton	-	-	-
0,39 Ton	1,10 Ton	2 Ton	3,75 Ton
0,32 m ³	1,10 m ³	2,40 m ³	4,30 m ³
130 bar	150 bar	200 bar	320/5 bar
40 l/min.	60 l/min.	120 l/min.	160 l/min.



GLODALICA

MB Crusher GLODALICE, širok spektar kompaktnih i efikasnih glodalica, dizajniranih sa niskim centrom gravitacije da bi redukovale torzije i vibracije na rovokopačkoj grani mašine. MB Crusher glodalice su jedine na tržištu koje imaju direktan pogon sa duplim motorom.

- + KOMPAKTAN I STABILAN**
- + JEDINSTVENI SISTEM DIREKTOG POGONA SA DUPLIM MOTOROM**
- + PRECIZAN I SVESTRAN**
- + SIGURAN I EFIKASAN**
- + HIDRAULIKA VISOKIH PERFORMANSI**

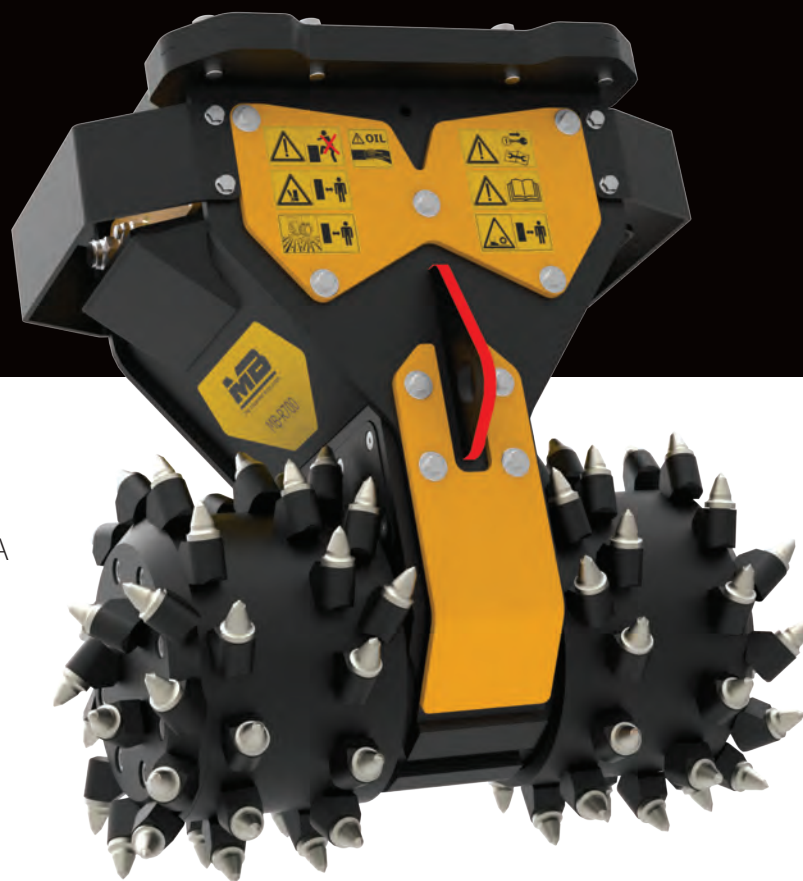

- + ZAMENLJIVI BUBANJ:**
BRZO I LAKO ODRŽAVANJE NA GRADILIŠTU
LAKA ZAMENA BUBNJA ZA MANJE OD 1 SATA



MODELI

MODEL				
	MB-R500	MB-R700	MB-R800	MB-R900
 PREPORUČENI BAGER	≥ 3,5 < 11 Ton	≥ 6 < 13 Ton	≥ 10 < 22 Ton	≥ 19 < 35 Ton
 PREPORUČENI MINI UTOVARIVAČ	≥ 3,5 Ton	-	-	-
MAX. SILA	19600 N	19600 N	33900 N	40000 N
BRZINA/min (MIN/MAX)	80/120	80/110	60/80	60/80
IZLAZNI MOMENT	5000 Nm	5000 Nm	10000 Nm	13200 Nm
PRITISAK / KONTRA PRITISAK	350/4 bar	350/4 bar	350/4 bar	350/4 bar
TEŽINA	0,3 Ton	0,6 Ton	1 Ton	1,4 Ton
PROTOK ULJA	60 - 120 l/min.	110-180 l/min.	200-300 l/min.	250-350 l/min.
PREČNIK BUBNJA	500 mm	500 mm	600 mm	680 mm

WWW.MBCRUSHER.COM



SAZNAJTE
VIŠE

MB PERFORMANSE



Kompleti remenica i zuba,
**RASPOLOŽIVO ZA SVE VRSTE
MATERIJALA**



Opremljen sa **ANTITORZIONIM
SISTEMOM** koji umanjuje prenosne
vibracije na bagersku ruku



Opremljen sa **ANTIREZISTENTNIM
PLOČAMA** kao zaštita kompletnog
tela glodalice



Opremljen mehanizmom koji
**SPREČAVA PREGREVANJE
HIDRAULIČNOG ULJA** na bageru



Opremljen sa **POWER BOOST**
sistemom. Povećava višestruko snagu
glodalice kada ona zahteva veću snagu



Može da radi pod **VODOM**



BRZO ZAMENJUJUĆI ZUBI

RAZLIČITE APLIKACIJE UPOTREBE

- USITNJAVANJE ZEMLJE, KAMENA, ASFALTA I CEMENTA
- KOMUNALNA DELATNOST
- RAZBIJANJE U URBANIM SREDINAMA
- ODRŽAVANJE PUTEVA I PROFILISANJE
- POVRŠINE PUTA
- TUNELSKO MLEVENJE
- POLJOPRIVREDA I ŠUMARSTVO

PRIBOR

- REDUCIR TEMPERATURE ULJA
- ODSTRANJIVAČ PRAŠINE
- MANJI KOMPLET ZA ODRŽAVANJE
- VELIKI KOMPLET ZA ODRŽAVANJE
- PRODUŽENA GARANCIJA GOLD 24
- PRPORUČENI REZ. DELOVI



GRABILICE ZA SORTIRANJE MATERIJALA

MB Crusher nudi širok spektar moćnih i snažnih grabilica, proizvedenih od najačih materijala, potpuno prilagođene za precizno rukovanje i odabir materijala

- +** JAKE I MOĆNE
- +** PRECIZNE
- +** INOVATIVNE
- +** JEDNOSTAVNE
- +** SIGURNE
- +** HARDOX®

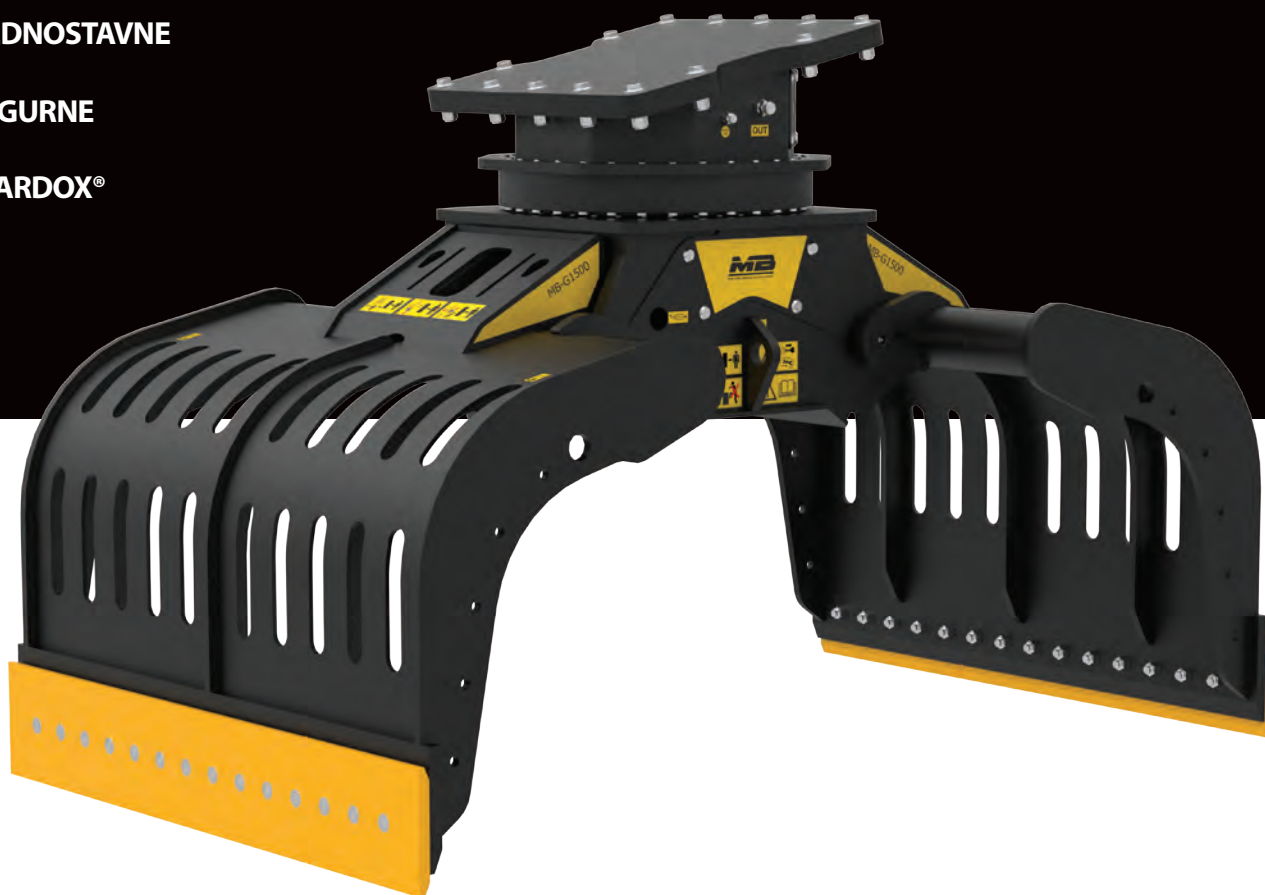

MODELI

				
MODEL	MB-G600 S2	MB-G900 S2	MB-G1200 S2	MB-G1500 S2
 PREPORUČENI BAGER	≥ 6 ≤ 12 Ton	≥ 12 ≤ 18 Ton	≥ 18 ≤ 25 Ton	≥ 20 ≤ 25 Ton
TEŽINA	0,60 Ton	0,78 Ton	1,60 Ton	2 Ton
KAPACITET UTOVARA (ZATVORENE ČELJUSTI)	0,29 m ³ / 290 L	0,43 m ³ / 430 L	0,71 m ³ / 710 L	1,43 m ³ / 1430 L
ROTACIJA	360°	360°	360°	360°
USMEREN PROTOK	15 ÷ 30 l/min.	15 ÷ 30 l/min.	20 ÷ 35 l/min.	20 ÷ 35 l/min.
PRITISAK ROTIRANJA	160 bar	160 bar	220 bar	220 bar
PRITISAK (OTVORENO/ZATVORENO)	200 ÷ 400 bar	200 ÷ 400 bar	300 ÷ 400 bar	300 ÷ 400 bar
PROTOK ULJA (OTVORENO/ZATVORENO)	25 l/min.	30 l/min.	70 l/min.	70 l/min.

WWW.MBCRUSHER.COM



SAZNAJTE
VIŠE

MB PERFORMANSE



BRZO I LAKO ODRŽAVANJE



Opremljen **KITOM ZA
POJAČANJE SNAGE**



**NOŽEVI MOGU BITI LAKO
ZAMENJENI NA GRADILIŠTU**



**POD UGLOM PRILAGOĐENI
SISTEM SPOJKI**



Opremljen sa
ZVUČNOM IZOLACIJOM



Opremljen sa **OPCIONIM
DODACIMA ZA RAZLIČITE
POTREBE U POSLU**

RAZLIČITE APLIKACIJE UPOTREBE

- RUŠENJE
- RAD U URBANIM SREDINAMA
- LUKE I TERETNI TERMINALI
- KAMENOLOMI
- RECIKLAŽA I SORTIRANJE OTPADA

PRIBOR

- KIT ZA POVEĆANJE SNAGE ROTACIJE
- OJAČANJE UNUTRAŠNJIH KANDŽI
- KOMPLET VIŠENAMENSKIH NOŽEVA
- KOMPLET ZAŠTITNA GUMA
- SET OPREME ŠKOLJKASTOG HVATAČA
- PRODUŽENA GOLD GARANCIJA 2 GODINE



90% UDELA NA
TRŽIŠTU (MARKET SHARE)

7 OGRANAKA
ŠIROM SVETA

PREKO 60
GODINA ISKUSTVA

100% ŽENE I MUŠKARCI
SA MB U SVOJIM SRCIMA

100%
MADE IN ITALY

100%
NAJBOLJI KVALITET

Rev. 2018/03 | PROJECT BY DDMADVERTISING.COM

SERVISNA MREŽA

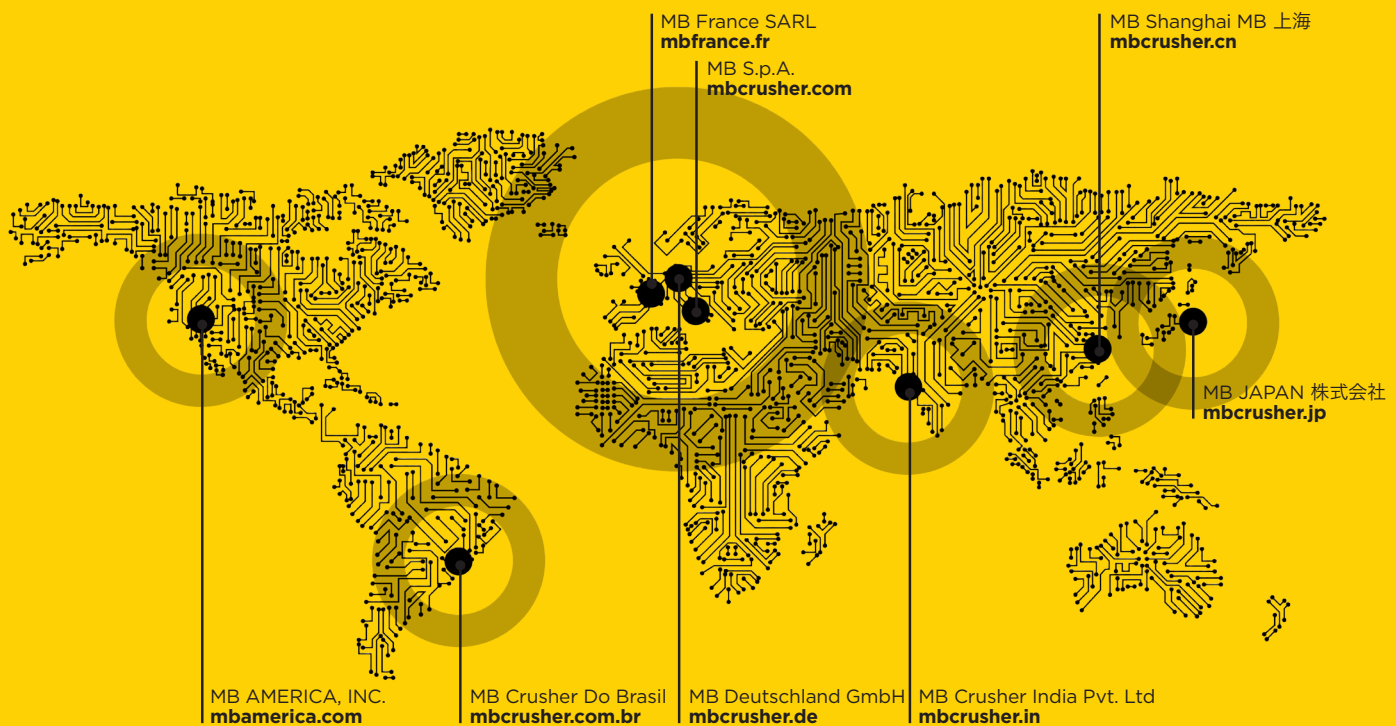

MB HEADQUARTERS

Via Astico 30/A, 36030 Fara Vicentino (VI) Italy
Tel +39 0445 308148 - Fax +39 0445 308179
info@mbcrusher.com

Ovlašćeni uvoznik, distributer i serviser
za Srbiju i Crnu Goru



tel/fax: +381 11 3169 711, 3169 712
e-mail: office@mcr-group.rs
www.mcr-group.rs



SAZNAJTE
VIŠE

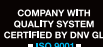

100%
MADE IN
ITALY

WWW.MBCRUSHER.COM



Prikazani podaci nisu obavezujući, jer proizvođač zadržava pravo da poboljša svoje proizvode u bilo koje vreme i bez prethodne najave. Napomene na težinu bagera su indikativne i mogu biti podložne promjenama. Uzmite u obzir toleranciju od 20%.